

IGBT Dual Transistor

MG100Q2YS42

1200V / 100A

DATASHEET

OEM – Toshiba

Source: Toshiba Databook 1995/96

MAXIMUM RATINGS (Ta=25°C)

CHARACTERISTIC	SYMBOL	RATING	UNIT
Collector-Emitter Voltage	Vces	1200	V
Gate-Emitter Voltage	Vges	+/-20	V
Collector Current	DC	IC	100
	1ms	Icp	200
Forward Current	DC	If	100
	1ms	Ifm	200
Collector Power Dissipation	Pc	700	W
Junction Temperature	Tj	150	°C
Storage Temperature Range	Tstg	-40~125	°C
Isolation Voltage	Visol	2500 (AC 1min.)	V
Screw Torque (Terminal / Mounting)	-	3/3	N*m

ELECTRICAL CHARACTERISTICS (Ta=25°C)

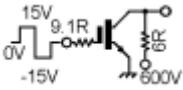
CHARACTERISTICS	SYMBOL	TEST CONDITION	MIN.	TYP.	MAX.	UNIT
Gate Leakage Current	Iges	Uge=+/-20V, Vce=0	-	-	+20	uA
Collector Cut-off Current	Ices	Uce=1200V, Uge=0	-	-	2.0	mA
Gate-Emitter Cut-off Voltage	Uge (off)	Ic=100mA, Uce=5V	3.0	-	6.0	V
Collector-Emitter Saturation Voltage	Uce (sat)	IC=100A, Uge=15V	-	3.0	4.0	V
Input Capacitance	Cies	Uce=10V, Uge=0, f=1MHz	-	12000	-	pF
Switching Time	Rise Time		-	0.30	0.60	uS
	Turn-on Time		-	0.40	0.80	
	Fall Time		-	0.20	0.50	
	Turn-off Time		-	0.8	1.50	
Forward Voltage	Vf	If=100A, Uge=0	-	2.0	2.5	V
Reverse Recovery Time	trr	If=100A, Uge=-10V di/dt=200A/uS	-	0.25	0.50	uS
Thermal Resistance	Rth (j-c)	Transistor	-	-	0.179	°C/W
		Diode	-	-	0.50	

2-109C1A

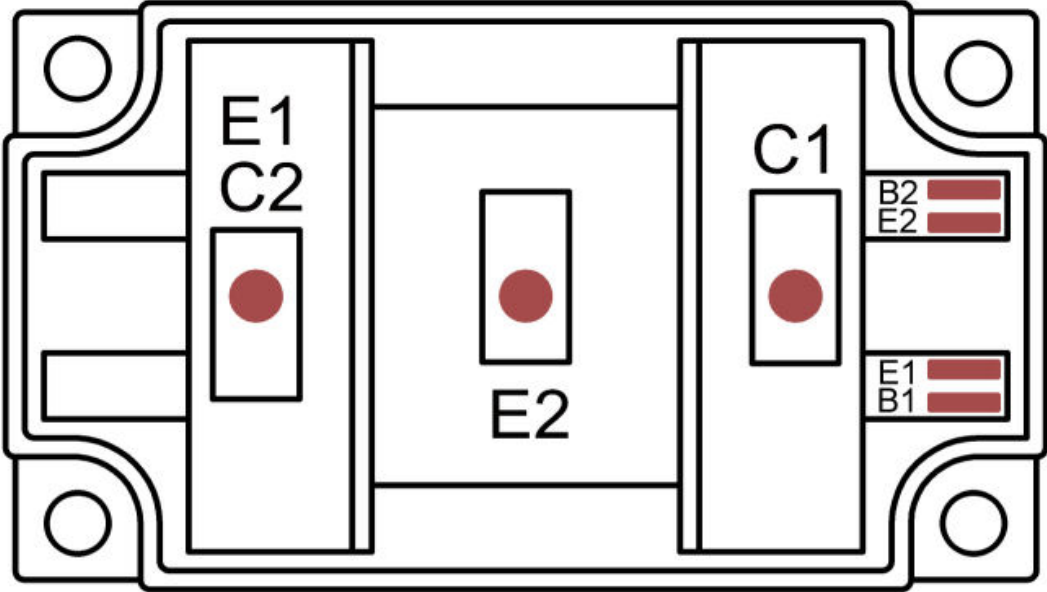

EQUIVALENT CIRCUIT

