

# Silicon Diode

## **1N6478**

50V / 1A

# DATASHEET

from

[www.web-bcs.com](http://www.web-bcs.com)

OEM – General Semiconductor

Source: General Semiconductor Databook 1998

# 1N6478 THRU 1N6484

## SURFACE MOUNT GLASS PASSIVATED JUNCTION RECTIFIER

Reverse Voltage - 50 to 1000 Volts Forward Current - 1.0 Ampere

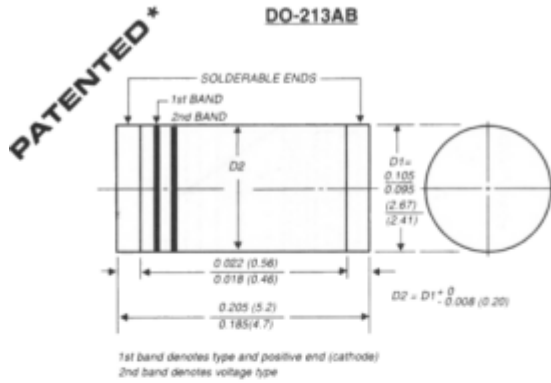

### FEATURES

- ◆ Plastic package has Underwriters Laboratory Flammability Classification 94V-0
- ◆ For surface mount applications
- ◆ High temperature metallurgically bonded construction
- ◆ Glass passivated cavity-free junction
- ◆ Capable of meeting environmental standards of MIL-S-19500
- ◆ High temperature soldering guaranteed: 450°C/5 seconds at terminals. Complete device submersible temperature of 265°C for 10 seconds in solder bath



### MECHANICAL DATA

**Case:** JEDEC DO-213AB molded plastic over glass body  
**Terminals:** Plated terminals, solderable per MIL-STD-750, Method 2026

**Polarity:** Two bands indicate cathode end - 1st band denotes device type and 2nd band denotes repetitive peak reverse voltage rating

**Mounting Position:** Any

**Weight:** 0.0046 ounce, 0.116 gram

### MAXIMUM RATINGS AND ELECTRICAL CHARACTERISTICS

Ratings at 25°C ambient temperature unless otherwise specified.

Standard recovery time device: 1st band is White	SYMBOLS	1N 6478	1N 6479	1N 6480	1N 6481	1N 6482	1N 6483	1N 6484	UNITS
Polarity color bands (2nd Band)		Gray	Red	Orange	Yellow	Green	Blue	Violet	
* Maximum repetitive peak reverse voltage	VRRM	50	100	200	400	600	800	1000	Volts
Maximum RMS voltage	VRMS	35	70	140	280	420	560	700	Volts
* Maximum DC blocking voltage	VDC	50	100	200	400	600	800	1000	Volts
* Maximum average forward rectified current at	I(AV)	1.0							Amp
* Peak forward surge current 8.3ms single half sine-wave superimposed on rated load at TA=75°C (JEDEC Method)	IFSM	30.0							Amps
* Maximum instantaneous forward voltage at 1.0A TA=25°C TA=75°C	VF	1.1 1.0							Volts
* Maximum DC reverse current at rated DC blocking voltage TA=25°C TA=125°C	IR	10.0 200.0							µA
* Maximum full load reverse current, full cycle average at TA=75°C	IR(AV)	100.0							µA
* Typical junction capacitance (NOTE 1)	CJ	8.0							pF
* Maximum thermal resistance (NOTE 2) (NOTE 3)	REJA REJT	50.0 20.0							°C/W
* Operating junction and storage temperature range	TJ, TSTG	-65 to +175							°C

**NOTES:**

- (1) Measured at 1.0 MHz and applied reverse voltage of 4.0 Volts
  - (2) Thermal resistance from junction to terminal, 0.24 x 0.24" (6.0 x 6.0mm) copper pads to each terminal
  - (3) Thermal resistance from junction to ambient, 0.24 x 0.24" (6.0 x 6.0mm) copper pads to each terminal
- \* JEDEC Registered Values

**RATINGS AND CHARACTERISTIC CURVES 1N6478 THRU 1N6484**

